

TOMEI Camshaft Spec Card

The Engine Specialist

PART NAME PROCAM ENGINE RB26DETT 32/33

PART NUMBER SET TA301A-NS05J IN TA301C-NS05E * EX TA301E-NS05J

*32/33/34 compatible

GRIND	IN	292° /11.50mm	SOLID
	EX	292° /11.50mm	SOLID

LIFT	IN	@CAM 11.50mm	@VALVE 11.05mm
	EX	@CAM 11.50mm	@VALVE 11.12mm

LOBE CENTER(°)	IN	110.0
	EX	115.0

BASE CIRCLE	IN	Φ30.0
	EX	Φ30.0

VALVE CLEARANCE WHEN COLD	IN	0.45mm
	EX	0.38mm

ROCKER ARM RATIO*	-
-------------------	---

* ALL LIFTS ARE BASED ON ZERO LASH AND THORETICAL ROCKER ARM RATIOS

CAM TIMING		OPENS(°)		CLOSES(°)		Actual Duration @ Opening(°)
Actual Duration Valve Lift	IN	BTDC	36.0	ABDC	76.0	292.0
	EX	BBDC	81.0	ATDC	31.0	292.0

Values shown are, from start to the end of actual duration. (Excluding the ramp values)

CAM TIMING		OPENS(°)		CLOSES(°)		TOTAL DURATION(°)
at 1mm Valve Lift	IN	BTDC	18.0	ABDC	58.0	256.0
	EX	BBDC	63.0	ATDC	13.0	256.0

Values are of actual duration from start to end of 1mm value points. (Excluding the ramp values)

CAM TIMING		OPENS(°)		CLOSES(°)		TOTAL DURATION(°)
at 0.05" Valve Lift	IN	BTDC	16.0	ABDC	56.0	252.0
	EX	BBDC	61.0	ATDC	11.0	252.0

Values are of actual duration from start to end of 0.05" value points. (Excluding the ramp values)

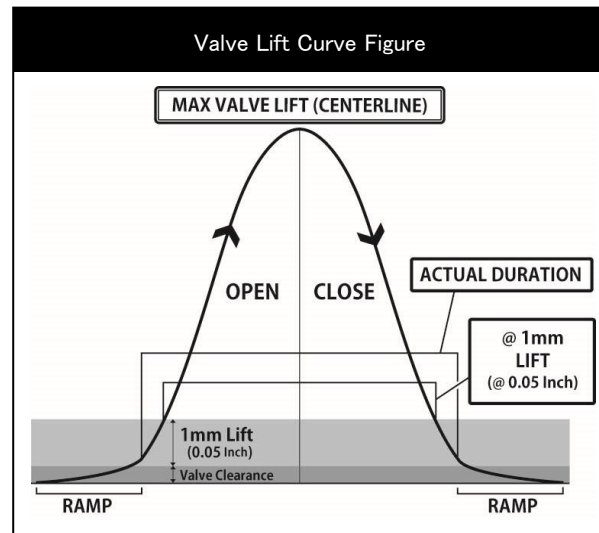

REQUIRED VALVE SPRING SPEC	
NORMAL HEIGHT	45.0mm
SET LENGTH	40.2mm
LIFT LENGTH	29.0mm
COMPRESSED HEIGHT	28.0mm
SET LOAD	24.0kgf±7%
LIFT LOAD	97.8kgf±7%
PART NUMBER	173002

REQUIRED PARTS	
PRODUCT NAME	PART NUMBER
VALVE LIFTER SET RB26DETT	TA307A-NS05A

Dowel pin position when first cam lobe is pointing upwards.

IN

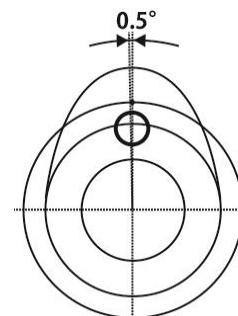

EX

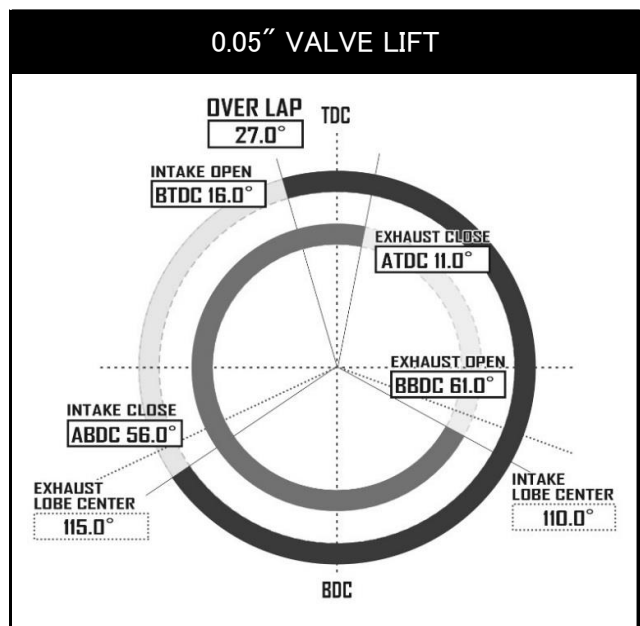
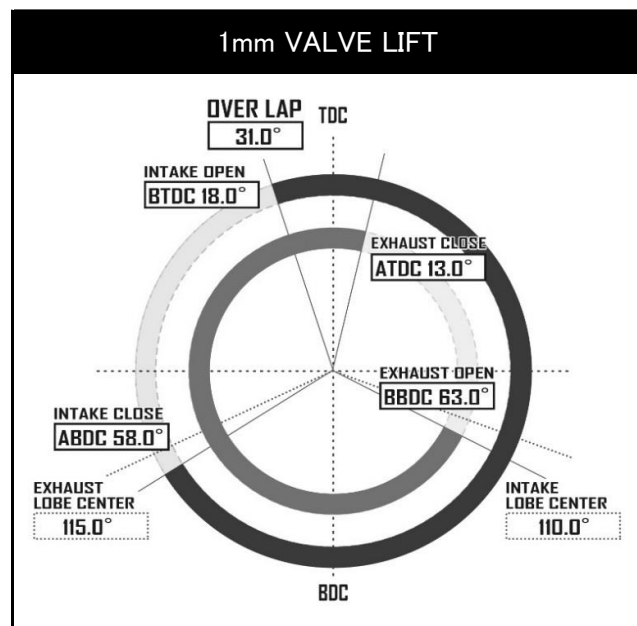
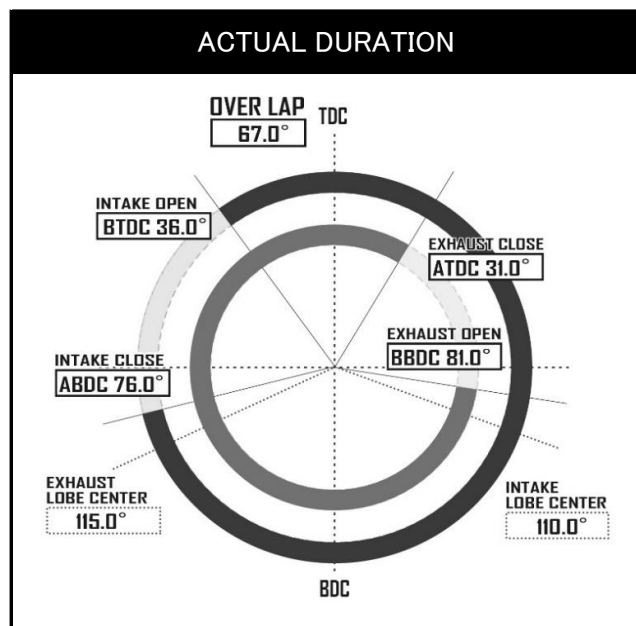
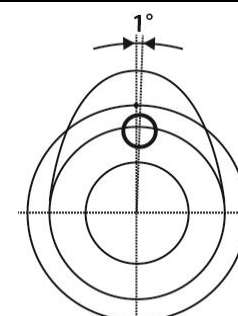

TOMEI Camshaft Spec Card

The Engine Specialist

品名 PROCAM 適合 RB26DETT 32/33

品番 SET TA301A-NS05J IN TA301C-NS05E * EX TA301E-NS05J

スペック	IN	292° /11.50mm	SOLID
	EX	292° /11.50mm	SOLID

リフト	IN	@CAM 11.50mm	@VALVE 11.05mm
	EX	@CAM 11.50mm	@VALVE 11.12mm

初期設定 中心角(°)	IN	110.0
	EX	115.0

ベース円	IN	Φ30.0
	EX	Φ30.0

*32/33/34共通

冷間時 バルブクリアランス	IN	0.45mm
	EX	0.38mm

ロッカーアームレシオ*	-
-------------	---

*すべてのリフト値はラッシュアジャスターが動作していない時、およびロッカーアームレシオから計算した理論値です。

カムタイミング		OPENS(°)		CLOSES(°)		Actual Duration @ Opening(°)
有効作用角 バルブリフト	IN	BTDC	36.0	ABDC	76.0	292.0
	EX	BBDC	81.0	ATDC	31.0	292.0

ランプ部を除いた有効作用角の始点と終点の数値

カムタイミング		OPENS(°)		CLOSES(°)		TOTAL DURATION(°)
1mm バルブリフト	IN	BTDC	18.0	ABDC	58.0	256.0
	EX	BBDC	63.0	ATDC	13.0	256.0

ランプ部を含めたバルブの開き始めと閉じ終わりから1mmの点での数値

カムタイミング		OPENS(°)		CLOSES(°)		TOTAL DURATION(°)
0.05" バルブリフト	IN	BTDC	16.0	ABDC	56.0	252.0
	EX	BBDC	61.0	ATDC	11.0	252.0

ランプ部を含めたバルブの開き始めと閉じ終わりから0.05インチの点での数値

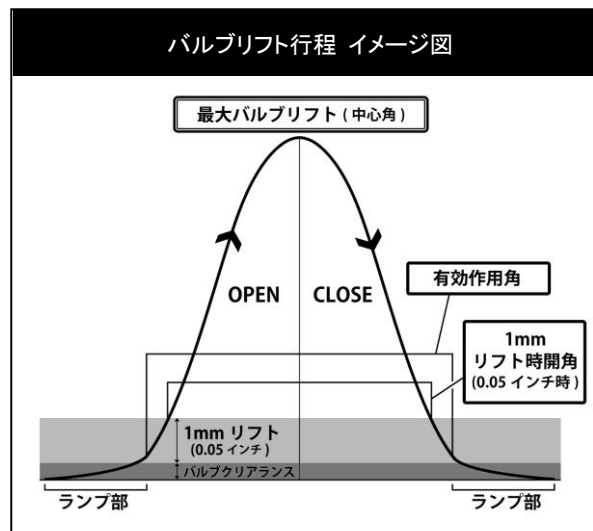

推奨バルブスプリング	
自由長	45.0mm
セット長	40.2mm
リフト長	29.0mm
密着長	28.0mm
セット荷重	24.0kgf±7%
リフト荷重	97.8kgf±7%
品番	173002

必要部品	
製品名	品番
VALVE LIFTER SET RB26DETT	TA307A-NS05A

第1カム山をトップ位置にした際の
ノックピン位置

